

RECOVERY AND PATIENT TRANSPORT TABLES
COLLECTION 2021 - PROVEN NEW COMBINED



Präzisions-
Stahlrohrmöbel

2021.1



TABLES FOR SURGERY AND HOSPITAL

... WITH FIXED HEIGHT



SERIES DFH

... WITH HYDRAULIC HEIGHT ADJUSTMENT



SERIES 2000XL



SERIES DX1

Recovery and patient transport tables



+



+



+



=



Recovery and patient transport table ✓

Content

Recovery and patient transport tables - Your advantages	3
Recovery and patient transport tables with fixed height Series DFH	4
2-sectioned recovery and patient transport tables with fixed height:	
• Model 61 Length head part: 550 mm	6
• Model 60 Length head part: 750 mm	8
3-sectioned recovery and patient transport tables with fixed height:	
• Model 71 Length head part: 550 mm	10
• Model 70 Length head part: 750 mm	12
Recovery and patient transport tables with hydraulic height adjustment Series 2000XL	14
2-sectioned recovery and patient transport tables:	
• Model 2220XL/H Length head part: 550 mm	16
• Model 2210XL/H Length head part: 750 mm	18
3-sectioned recovery and patient transport tables:	
• Model 2250XL/H Length head part: 750 mm	20
2-sectioned recovery and patient transport tables with inclination adjustment (Trendelenburg):	
• Model 2320XL/H Length head part: 550 mm	22
• Model 2310XL/H Length head part: 750 mm	24
2-sectioned recovery and patient transport tables with inclination adjustment (Trendelenburg) and detachable mattress	
• Model 2410XL/H Length head part: 750 mm	26
Recovery and patient transport tables Series DX1	28
2-sectioned recovery and patient transport tables:	
• Model 1090/H Length head part: 550 mm	30
• Model 1093/H Length head part: 750 mm	32
3-sectioned recovery and patient transport tables:	
• Model 1095/H Length head part: 550 mm	34
Additional equipment	35



Recovery and patient transport tables

Your advantages



Recovery upholstery:

- Thickness of upholstery: 80 mm; Series DX1: 70 mm
- Multiple glued, high-strength laminated wood panel (thickness: 18 mm), partly ply wood; no breaking chipboards in case of pressure on the edges
- Two-layer homogenous polyurethane foam, density 46 and 75, Ökotex-certified
- 2 different variants for artificial leather eligible for upholstery covering:
 - Skai® Pandoria Plus with velvet-smooth surface
 - Skai® Toronto EN with innovative staynu-technology



Dewert-hygiene-equipment

Enables optimal cleaning and disinfection

- Artificial leather underneath the upholstery
- Vent holes underneath the upholstery, closed by special caps with valve function
- Easy hygiene because of an open construction: good accessibility of components, no plastic coverings which are breakable in the ageing process
- Option: Innovative artificial leather Skai Toronto EN with staynu



Models with fixed height

pages 4 to 13



Models with hydraulic height adjustment

pages 14 to 35



Manual hydraulic
height adjustment

Series DFH: Recovery and patient transport tables with fixed height



Technology:



- Frame made of square tube, 30 x 30 x 2 mm
- Longitudinal brace and cross brace between the feet for additional stability
- Pairs of feet and frame are screwed together tightly
- Galvanised steel hinges connect the upholstery parts, no breaking plastic components
- Load capacity: 250 kg 



Basic equipment:



- **Recovery upholstery:**
Increased lying comfort due to medium-soft upholstery with a cold foam cover

- **Movable** on 4 castors, Ø 100 mm, each with lock



- 2 foldable **side guards**, lay down besides upholstery, below upholstery surface level, are completely made of steel tube without any breakable plastic components, RAL 9006 powder coated, length: 820 mm

- 1 **push handle**, chromium-plated, at foot part



- **Dewert-hygiene-equipment**

You will find additional options on the following pages

Recovery and patient transport tables with fixed height

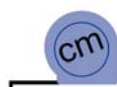

- Width of lying surface: 65 cm, optional 80 cm
- Height: 69 cm



Variants:

Length head part 550 mm:

- 2 stable parallel mounted safety metal ratchets for positive adjustment of head part
→ Optional: Comfortable adjustment by gas spring, stepless to +40°



Length head part 750 mm:

- Comfortable adjustment by gas spring, stepless to +75° to sitting position of patient

With 2-sectioned lying surface:

- Head part positive adjustable
- Fixed foot part, not adjustable



NEW

With 3-sectioned lying surface:

- Head part positive adjustable
- Fixed middle part
- Foot part positive adjustable to +35° by gas spring

Recovery and patient transport tables

2-sectioned recovery and patient transport table with fixed height

Length head part: 550 mm

Model 61-00 white powder coated (RAL 9010)

Model 61-03 white aluminium powder coated (RAL 9006)

Model 61-04 silver aluminium powder coated (RAL 9007)

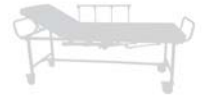

Both pictures:
Model 61-00
with option:
2nd push handle at head part
(1810)

Basic equipment:

- Table movable on 4 castors, Ø 100 mm, each with lock
- Longitudinal brace for additional stability
- 1 push handle, chromium-plated, mounted at foot part (optional at head part possible)
- 2 side guards, foldable, RAL 9006 powder coated, length: 820 mm
- Recovery upholstery
- Dewert-hygiene-equipment



Upholstery:

Lying surface 2-sectioned:

- Head part upwards (+30°) adjustable by 2 metal ratchets
- Length head part: 550 mm
- Fixed foot part
- Length foot part: 1400 mm
- Upholstery thickness: 80 mm



Technical data:

- Length of lying surface: 1950 mm | Length overall: 2080 mm
- Width of lying surface: 650 mm | Width overall: 750 mm | optional width: 800 mm, width overall: 900 mm
- Height: 690 mm
- Load capacity: 250 kg



Design:

2 different variants for artificial leather eligible for upholstery covering:

- Skai® Pandoria Plus with velvet-smooth surface
- Skai® Toronto EN with innovative staynu-technology



Available as an option (see pricelist for additional options)



Mobility



Art. no. 1120-EF
Without basic mobility



Art. no. 1140-11
Movable on 4 castors,
Ø 125 mm, each with
total lock



Art. no. 1180N
Movable on twin castors,
Ø 100 mm with central lock



Art. no. 1185
Movable on twin castors,
Ø 125 mm with central lock

Side guards



Art. no. 1088-EF
Without basic side guard



Art. no. 1040
1 side guard tiltable, chromium-plated,
completely made of steel tube,
length: 700 mm



Art. no. 1005
1 side guard to fit on side rail, with
attachment clamp, chromium-plated,
length: 800 mm,

Head part options



Art. no. 1655-20
Head part stepless adjustable
by gas spring (0° to +55°)



Art. no. 1662
Additional second head
part of the same size,
adjustable by 2 metal
ratchets



Art. no. 1610
Nose opening

Art. no. 1620
Upholstery part to close

Paper roll holder



Art. no. 1210 / 1220
Paper roll holder,
for width
650 mm / 800 mm

Wall protection bumpers

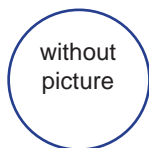

Art. no. 1172
4 wall protection bumpers
Ø 100 mm

Add-on elements



Art. no. 1810
1 additional push handle



Art. no. 1850
Storage basket with mounting,
measures:
L. 530 x W. 370 x H. 80 mm



Art. no. 1410
1 piece of side rail, length:
350 mm



Art. no. 1430
1 attachment clamp for
side rail,
suitable for pipe: Ø 18 mm



Art. no. 1450
Infusion pole for side
rail, without attachment
clamp

Upholstery options

Art. no. 61-800
Width of upholstery 800 mm

Art. no. 1765 / 1780
Soft covering for pleasant resting
comfort, for width 650 mm / 800 mm,
thickness 80 mm

Recovery and patient transport tables

2-sectioned recovery and patient transport table with fixed height

Length head part: 750 mm

Model 60-00 white powder coated (RAL 9010)

Model 60-03 white aluminium powder coated (RAL 9006)

Model 60-04 silver aluminium powder coated (RAL 9007)



Both pictures:
Model 60-00
in basic equipment



Basic equipment:

- Table movable on 4 castors, Ø 100 mm, each with lock
- Longitudinal brace for additional stability
- 1 push handle, chromium-plated, mounted at foot part (optional at head part possible)
- 2 side guards, foldable, RAL 9006 powder coated, length: 820 mm
- Recovery upholstery
- Dewert-hygiene-equipment 

Upholstery:

Lying surface 2-sectioned:

- Head part stepless adjustable to +75° by gas spring (sitting position)
- Length head part: 750 mm
- Fixed foot part
- Length foot part: 1200 mm
- Upholstery thickness: 80 mm



Technical data:

- Length of lying surface: 1950 mm | Length overall: 2080 mm
- Width of lying surface: 650 mm | Width overall: 750 mm | optional width: 800 mm, width overall: 900 mm
- Height: 690 mm
- Load capacity: 250 kg 



Design:

2 different variants for artificial leather eligible for upholstery covering:

- Skai® Pandoria Plus with velvet-smooth surface
- Skai® Toronto EN with innovative staynu-technology



Available as an option (see pricelist for additional options)



Mobility



Art. no. 1120-EF
Without basic mobility



Art. no. 1140-11
Movable on 4 castors,
Ø 125 mm, each with
total lock



Art. no. 1180N
Movable on twin castors,
Ø 100 mm with central lock



Art. no. 1185
Movable on twin castors,
Ø 125 mm with central lock

Side guards



Art. no. 1088-EF
Without basic side rail



Art. no. 1040
1 side guard tiltable, chromium-plated,
completely made of steel tube,
length: 700 mm



Art. no. 1005
1 side guard to fit on side rail, with
attachment clamp, chromium-plated,
length: 800 mm,

Head part options



Art. no. 1662
Additional second head part of the
same size,
adjustable by 2 metal rachets



Art. no. 1610
Nose opening

Art. no. 1620
Upholstery part to close

Paper roll holder



Art. no. 1210 / 1220
Paper roll holder,
for width
650 mm / 800 mm

Wall protection bumpers

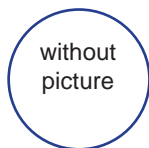

Art. no. 1172
4 wall protection bumpers
Ø 100 mm



Art. no. 1810
1 additional push handle



Art. no. 1850
Storage basket with mounting,
measures:
L. 530 x W. 370 x H. 80 mm

Upholstery options



Art. no. 1410
1 piece of side rail, length:
350 mm



Art. no. 1430
1 attachment clamp for
side rail,
suitable for pipe: Ø 18 mm



Art. no. 1450
Infusion pole for side
rail, without attachment
clamp

Art. no. 60-800
Width of upholstery 800 mm

Art. no. 1765 / 1780
Soft covering for pleasant resting
comfort, for width 650 mm / 800 mm,
thickness 80 mm

Recovery and patient transport tables

3-sectioned recovery and patient transport table with fixed height

Length head part: 550 mm

Model 71-00 white powder coated (RAL 9010)

Model 71-03 white aluminium powder coated (RAL 9006)

Model 71-04 silver aluminium powder coated (RAL 9007)

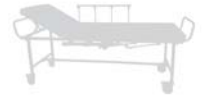

Both pictures:
Model 71-00
with options:
Movable on twin castors
with central lock (1180N),
adjustment of head part
by gas spring (1655)

Basic equipment:

- Table movable on 4 castors, Ø 100 mm, each with lock
- Longitudinal brace for additional stability
- 1 push handle, chromium-plated, mounted at foot part (optional at head part possible)
- 2 side guards, foldable, RAL 9006 powder coated, length: 820 mm
- Recovery upholstery
- Dewert-hygiene-equipment



Upholstery:

Lying surface 3-sectioned:

- Head part upwards (+30°) adjustable by 2 metal rachets
- Length head part: 550 mm
- Fixed middle part
- Length middle part: 450 mm
- Foot part stepless adjustable by gas spring (0° to +32°)
- Length foot part: 950 mm
- Upholstery thickness: 80 mm



Technical data:

- Length of lying surface: 1950 mm | Length overall: 2080 mm
- Width of lying surface: 650 mm | Width overall: 750 mm | optional width: 800 mm, width overall: 900 mm
- Height: 690 mm
- Load capacity: 250 kg



Design:

2 different variants for artificial leather eligible for upholstery covering:

- Skai® Pandoria Plus with velvet-smooth surface
- Skai® Toronto EN with innovative staynu-technology



Available as an option (see pricelist for additional options)



Mobility



Art. no. 1120-EF
Without basic mobility



Art. no. 1140-11
Movable on 4 castors,
Ø 125 mm, each with
total lock



Art. no. 1180N
Movable on twin castors,
Ø 100 mm with central lock



Art. no. 1185
Movable on twin castors,
Ø 125 mm with central lock

Side guards



Art. no. 1088-EF
Without basic side rail



Art. no. 1040
1 side guard tiltable, chromium-plated,
completely made of steel tube,
length: 700 mm



Art. no. 1005
1 side guard to fit on side rail, with
attachment clamp, chromium-plated,
length: 800 mm,

Head part options



Art. no. 1655-20
Head part stepless adjustable
by gas spring (0° to +55°)



Art. no. 1610
Nose opening

Art. no. 1620
Upholstery part to close

Paper roll holder



Art. no. 1210 / 1220
Paper roll holder,
for width 650 mm / 800 mm

Wall protection bumpers

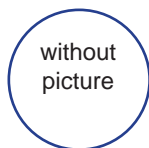

Art. no. 1172
4 wall protection bumpers
Ø 100 mm



Art. no. 1810
1 additional push handle



Art. no. 1850
Storage basket with mounting,
measures:
L. 530 x W. 370 x H. 80 mm

Art. no. 1410
1 piece of side rail, length:
350 mm



Art. no. 1430
1 attachment clamp for
side rail,
suitable for pipe: Ø 18 mm



Art. no. 1450
Infusion pole for side
rail, without attachment
clamp



Upholstery options

Art. no. 71-800
Width of upholstery 800 mm

Art. no. 1765 / 1780
Soft covering for pleasant resting
comfort, for width 650 mm / 800 mm,
thickness 80 mm

Recovery and patient transport tables

3-sectioned recovery and patient transport table with fixed height

Length head part: 750 mm

Model 70-00 white powder coated (RAL 9010)

Model 70-03 white aluminium powder coated (RAL 9006)

Model 70-04 silver aluminium powder coated (RAL 9007)



Both pictures:
Model 70-00
with option: 2nd push handle
(1810)

Basic equipment:

- Table movable on 4 castors, \varnothing 100 mm, each with lock
- Longitudinal brace for additional stability
- 1 push handle, chromium-plated, mounted at foot part (optional at head part possible)
- 2 side guards, foldable, RAL 9006 powder coated, length: 820 mm
- Recovery upholstery
- Dewert-hygiene-equipment



Upholstery:

Lying surface 3-sectioned:

- Head part stepless adjustable (0° to $+80^\circ$) by gas spring (sitting position)
- Length head part: 750 mm
- Fixed middle part
- Length middle part: 300 mm
- Foot part stepless adjustable by gas spring (0° to $+30^\circ$)
- Length foot part: 900 mm
- Upholstery thickness: 80 mm

Technical data:

- Length of lying surface: 1950 mm | Length overall: 2080 mm
- Width of lying surface: 650 mm | Width overall: 750 mm | optional width: 800 mm, width overall: 900 mm
- Height: 690 mm
- Load capacity: 250 kg

Design:

2 different variants for artificial leather eligible for upholstery covering:

- Skai® Pandoria Plus with velvet-smooth surface
- Skai® Toronto EN with innovative staynu-technology



Available as an option (see pricelist for additional options)



Mobility



Art. no. 1120-EF
Without basic mobility



Art. no. 1140-11
Movable on 4 castors,
Ø 125 mm, each with
total lock



Art. no. 1180N
Movable on twin castors,
Ø 100 mm with central lock



Art. no. 1185
Movable on twin castors,
Ø 125 mm with central lock

Side guards



Art. no. 1088-EF
Without basic side rail



Art. no. 1040
1 side guard tiltable, chromium-plated,
completely made of steel tube,
length: 700 mm



Art. no. 1005
1 side guard to fit on side rail, with
attachment clamp, chromium-plated,
length: 800 mm,

Head part options



Art. no. 1610
Nose opening

Art. no. 1620
Upholstery part to close

Paper roll holder



Art. no. 1210 / 1220
Paper roll holder,
for width 650 mm / 800 mm

Wall protection bumpers

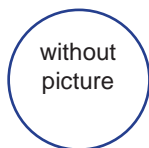

Art. no. 1172
4 wall protection bumpers
Ø 100 mm

Add-on elements



Art. no. 1810
1 additional push handle



Art. no. 1850
Storage basket with mounting,
measures:
L. 530 x W. 370 x H. 80 mm



Art. no. 1410
1 piece of side rail, length:
350 mm



Art. no. 1430
1 attachment clamp for
side rail,
suitable for pipe: Ø 18 mm



Art. no. 1450
Infusion pole for side
rail, without attachment
clamp

Upholstery options

Art. no. 70-800
Width of upholstery 800 mm

Art. no. 1765 / 1780
Soft covering for pleasant resting
comfort, for width 650 mm / 800 mm,
thickness 80 mm

Series 2000XL: Recovery and patient transport tables with hydraulic height adjustment



Picture with special option:
Strap guides below side guards

Technology:

- Manual foot operated height adjustment by a hydraulic pump
- Pedals for foot-controlled height positioning **on both sides** of the table
- Load capacity: 250 kg 
- Extremely stable **twin frame scissor lifting system**, with high torsional stiffness due to thick-walled square tubes with big dimensions, also for under and upper frame and scissor
- High stability due to massive 20 mm axes
- Widely-spaced feet and a high deadweight guarantee stability
- Robust frame construction which is proven in demanding everyday life of hospitals for years
- Abrasion-resistant guide system at under and upper frame due to the use of roller bearings

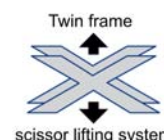
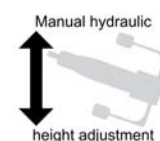

Basic equipment:

- **Recovery upholstery:**
Increased lying comfort due to medium-soft upholstery with a cold foam cover
- **Movable** on 4 comfort twin castors, Ø 125 mm, with central lock
- 2 foldable **side guards**, lay down besides upholstery, below upholstery surface level, are completely made of steel tube without any breakable plastic components, chromium-plated, length: 1.060 mm
- Good handling when pushing the table due to 2 **push handles** placed at the frame outside points, chromium-plated
- Longitudinal and lateral wall protection due to four **wall bumpers**
- **Dewert-hygiene-equipment**

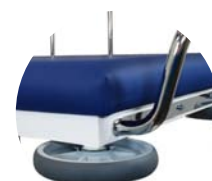

You will find additional options on the following pages

Series 2000XL: Recovery and patient transport tables with hydraulic height adjustment

Variants:



Length head part 550 mm:

- 2 stable parallel mounted safety metal ratchets for positive adjustment of head part
→ Optional: Comfortable adjustment by gas spring, stepless to +40°

Length head part 750 mm:

- Comfortable adjustment by gas spring, stepless to +75° to sitting position of patient



With 2-sectioned lying surface:

- Fixed foot part, not adjustable

With 3-sectioned lying surface:

- Head part positive adjustable
- Fixed middle part
- Foot part positive adjustable to +35° by gas spring



With 2-sectioned lying surface and inclination adjustment:

- Lying surface inclinable to 12° (Trendelenburg) by gas spring



With 2-sectioned lying surface, inclination adjustment and detachable mattress:

- Detachable mattress, thickness: 10 cm
- Upholstery made of high-quality resilience (cold) foam, covered with leatherette
- Mattress with velcro fastening and zipper at the bottom
- Support plate for mattress made of HPL panels (resistant to disinfectants)



Series 2000XL: Recovery and patient transport tables

2-sectioned recovery and patient transport table with hydraulic height adjustment

Length head part: 550 mm

Model 2220-00XL/H white powder coated (RAL 9010)

Model 2220-03XL/H white aluminium powder coated (RAL 9006)

Model 2220-04XL/H silver aluminium powder coated (RAL 9007)

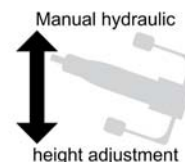

Model 2220-00XL/H with option: Storage basket (1850)

Basic equipment:

- Pedals for foot-controlled height positioning on both sides of the table
- Table movable on 4 comfort twin castors, Ø 125 mm, with central lock, 1 castor with direction lock
- 2 push handles at head and foot part, chromium-plated
- 2 side guards, foldable, chromium-plated, length: 1060 mm
- 4 wall protection bumpers, Ø 200 mm
- Recovery upholstery
- Dewert-hygiene-equipment 

Upholstery:

Lying surface 2-sectioned:

- Head part adjustable from 0° to +30° by 2 metal ratchets
- Length head part: 550 mm
- Fixed foot part
- Length foot part: 1400 mm
- Upholstery thickness: 80 mm



Model 2220-00XL/H with option: Without basic side guards, side guards tiltable (2x1040), paper roll holder (1267K), movable on twin castors with central lock (1180N)

Technical data:

- Manual foot operated height adjustment: 570 mm to 990 mm by hydraulic pump, pressure capacity of 10000 N
- Length of lying surface: 1950 mm | Length overall: 2200 mm
- Width of lying surface: 650 mm | Width overall: 800 mm | optional width: 800 mm, width overall: 950 mm
- Load capacity: 250 kg

Design:

2 different variants for artificial leather eligible for upholstery covering:

- Skai® Pandoria Plus with velvet-smooth surface
- Skai® Toronto EN with innovative staynu-technology



Available as an option (see pricelist for additional options)

Mobility



Art. no. 1183
Without basic mobility



Art. no. 1195
Movable on comfort twin castors, Ø 150 mm with central lock, antistatic, basic height + 70 mm



Art. no. 1199
Footbar for central lock, at foot end

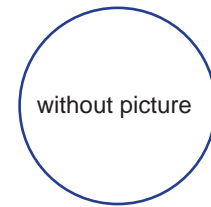

Art. no. 1190
5th castor, connectible, in the centre of the under frame

Side guards



Art. no. 1080-EF
Without basic side rail (1 piece)



Art. no. 1040
1 side guard tiltable, chromium-plated, completely made of steel tube, length: 700 mm, with wall protection bumpers Ø 150 mm



Art. no. 1005
1 side guard to fit on side rail, with attachment clamp, chromium-plated, length: 800 mm,

Head part options



Art. no. 1655-30
Comfortable stepless adjustment of head part by gas spring (0° to +60°)

Upholstery options

Art. no. 2220-800
Width of upholstery 800 mm, width overall 950 mm

Art. no. 1765 / 1780
Soft covering for pleasant resting comfort, for width 650 mm / 800 mm, thickness 80 mm

Paper roll holder



Art. no. 1267K / 1268K
Paper roll holder, mounted under head part, for width 650 mm / 800 mm

Add-on elements



Art. no. 1410
1 piece of side rail, length: 350 mm



Art. no. 1430
1 attachment clamp for side rail, suitable for pipe: Ø 18 mm



Art. no. 1450
Infusion pole for side rail, without attachment clamp



Art. no. 1850
Storage basket with mounting, measures:
L. 530 x W. 370 x H. 80 mm

Series 2000XL: Recovery and patient transport tables

2-sectioned recovery and patient transport table with hydraulic height adjustment

Length head part: 750 mm

Model 2210-00XL/H white powder coated (RAL 9010)

Model 2210-03XL/H white aluminium powder coated (RAL 9006)

Model 2210-04XL/H silver aluminium powder coated (RAL 9007)

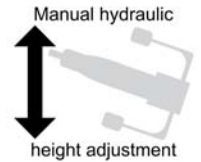

Both pictures:
Model 2210-00XL/H
with options:
Foot bar for centrallock
(1199), Storage basket
(1850)

Picture with special option:
Strap guides below side guards

Basic equipment:

- Pedals for foot-controlled height positioning on both sides of the table
- Table movable on 4 comfort twin castors, Ø 125 mm, with central lock, 1 castor with direction lock
- 2 push handles at head and foot part, chromium-plated
- 2 side guards, foldable, chromium-plated, length: 1060 mm
- 4 wall protection bumpers, Ø 200 mm
- Recovery upholstery
- Dewert-hygiene-equipment 

Upholstery:

Lying surface 2-sectioned:

- Head part stepless adjustable from 0° to +75° by gas spring (sitting position)
- Length head part: 750 mm
- Fixed foot part
- Length foot part: 1200 mm
- Upholstery thickness: 80 mm



Technical data:

- Manual foot operated height adjustment: 630 mm to 1050 mm by hydraulic pump, pressure capacity of 10000 N
- Length of lying surface: 1950 mm | Length overall: 2200 mm
- Width of lying surface: 650 mm | Width overall: 800 mm | optional width: 800 mm, width overall: 950 mm
- Load capacity: 250 kg 

Design:

2 different variants for artificial leather eligible for upholstery covering:

- Skai® Pandoria Plus with velvet-smooth surface
- Skai® Toronto EN with innovative staynu-technology

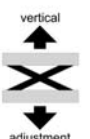

Available as an option (see pricelist for additional options)

Mobility



Art. no. 1183
Without basic mobility



Art. no. 1195
Movable on comfort twin
castors, Ø 150 mm with
central lock, antistatic,
basic height + 70 mm



Art. no. 1199
Footbar for central lock,
at foot end

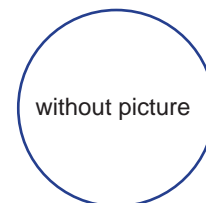

Art. no. 1190
5th castor, connectible,
in the centre of the under
frame

Side guards

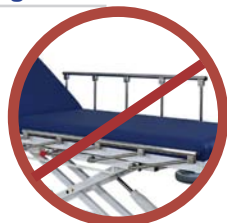

Art. no. 1080-EF
Without basic side rail (1 piece)



Art. no. 1040
1 side guard tiltable, chromium-plated,
completely made of steel tube,
length: 700 mm, with wall protection bum-
pers Ø 150 mm



Art. no. 1005
1 side guard to fit on side rail, with
attachment clamp, chromium-plated,
length: 800 mm,

Paper roll holder



Art. no. 1267K / 1268K
Paper roll holder, mounted
under head part, for width 650
mm / 800 mm

Upholstery options

Art. no. 2210-800
Width of upholstery 800 mm,
width overall 950 mm

Art. no. 1765 / 1780
Soft covering for pleasant resting
comfort, for width 650 mm / 800 mm,
thickness 80 mm

Add-on elements



Art. no. 1410
1 piece of side rail, length: 350 mm



Art. no. 1430
1 attachment clamp for side rail,
suitable for pipe: Ø 18 mm



Art. no. 1450
Infusion pole for side rail, without
attachment clamp



Art. no. 1850
Storage basket with mounting,
measures:
L. 530 x W. 370 x H. 80 mm

Series 2000XL: Recovery and patient transport tables

3-sectioned recovery and patient transport table with hydraulic height adjustment

Length head part: 750 mm

Model 2250-00XL/H white powder coated (RAL 9010)

Model 2250-03XL/H white aluminium powder coated (RAL 9006)

Model 2250-04XL/H silver aluminium powder coated (RAL 9007)

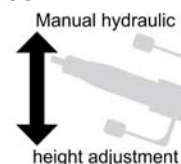

All pictures:
Model 2250-00XL/H
with option:
Paper roll holder (1267K)

Basic equipment:

- Pedals for foot-controlled height positioning on both sides of the table
- Table movable on 4 comfort twin castors, Ø 125 mm, with central lock, 1 castor with direction lock
- 2 push handles at head and foot part, chromium-plated
- 2 side guards, foldable, chromium-plated, length: 1060 mm
- 4 wall protection bumpers, Ø 200 mm
- Recovery upholstery
- Dewert-hygiene-equipment



Upholstery:

Lying surface 3-sectioned:

- Head part stepless adjustable from 0° to +75° by gas spring (sitting position)
- Length head part: 750 mm
- Fixed middle part
- Length middle part: 300 mm
- Foot part stepless adjustable from 0° to +35° by gas spring
- Length foot part: 900 mm
- Upholstery thickness: 80 mm



Technical data:

- Manual foot operated height adjustment: 630 mm to 1050 mm by hydraulic pump, pressure capacity of 10000 N
- Length of lying surface: 1950 mm | Length overall: 2200 mm
- Width of lying surface: 650 mm | Width overall: 800 mm | optional width: 800 mm, width overall: 950 mm
- Load capacity: 250 kg

Design:

2 different variants for artificial leather eligible for upholstery covering:

- Skai® Pandora Plus with velvet-smooth surface
- Skai® Toronto EN with innovative staynu-technology



Available as an option (see pricelist for additional options)

Mobility



Art. no. 1183
Without basic mobility



Art. no. 1195
Movable on comfort twin
castors, Ø 150 mm with
central lock, antistatic,
basic height + 70 mm



Art. no. 1199
Footbar for central lock,
at foot end

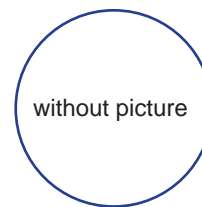

Art. no. 1190
5th castor, connectible,
in the centre of the under
frame

Side guards



Art. no. 1080-EF
Without basic side rail (1 piece)



Art. no. 1040
1 side guard tiltable, chromium-plated,
completely made of steel tube,
length: 700 mm, with wall protection bum-
pers Ø 150 mm



Art. no. 1005
1 side guard to fit on side rail, with
attachment clamp, chromium-plated,
length: 800 mm,

Paper roll holder



Art. no. 1267K / 1268K
Paper roll holder, mounted
under head part, for width 650
mm / 800 mm

Upholstery options

Art. no. 2250-800
Width of upholstery 800 mm,
width overall 950 mm

Art. no. 1765 / 1780
Soft covering for pleasant resting
comfort, for width 650 mm / 800 mm,
thickness 80 mm

Add-on elements



Art. no. 1410
1 piece of side rail, length: 350 mm



Art. no. 1430
1 attachment clamp for side rail,
suitable for pipe: Ø 18 mm



Art. no. 1450
Infusion pole for side rail, without
attachment clamp



Art. no. 1850
Storage basket with mounting,
measures:
L. 530 x W. 370 x H. 80 mm

Series 2000XL: Recovery and patient transport tables

2-sectioned recovery and patient transport table with hydraulic height and inclination adjustment

Length head part: 550 mm

Model 2320-00XL/H white powder coated (RAL 9010)

Model 2320-03XL/H white aluminium powder coated (RAL 9006)

Model 2320-04XL/H silver aluminium powder coated (RAL 9007)

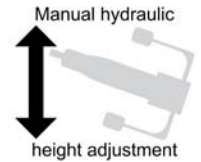

All pictures Model 2320-00XL/H with option: 2 side guards tiltable (2x 1040), with wall protection bumpers Ø 150 mm



Basic equipment:

- Pedals for foot-controlled height positioning on both sides of the table
- Table movable on 4 comfort twin castors, Ø 125 mm, with central lock, 1 castor with direction lock
- 2 push handles at head and foot part, chromium-plated
- 2 side guards, foldable, chromium-plated, length: 1060 mm
- 4 wall protection bumpers, Ø 200 mm
- Recovery upholstery
- Dewert-hygiene-equipment



Upholstery:

Lying surface 2-sectioned:

- Head part stepless adjustable from 0° to 60° by gas spring
- Length head part: 550 mm
- Fixed foot part
- Length foot part: 1400 mm
- Lying surface incinable till 12° (Trendelenburg) by gas spring
- Upholstery thickness: 80 mm

Technical data:

- Manual foot operated height adjustment: 640 mm to 1060 mm by hydraulic pump, pressure capacity of 10000 N
- Length of lying surface: 1950 mm | Length overall: 2200 mm
- Width of lying surface: 650 mm | Width overall: 800 mm | optional width: 800 mm, width overall: 950 mm
- Load capacity: 250 kg

Design:

2 different variants for artificial leather eligible for upholstery covering:

- Skai® Pandoria Plus with velvet-smooth surface
- Skai® Toronto EN with innovative staynu-technology

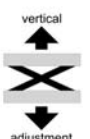

Available as an option (see pricelist for additional options)

Mobility



Art. no. 1183
Without basic mobility



Art. no. 1195
Movable on comfort twin
castors, Ø 150 mm with
central lock, antistatic,
basic height + 70 mm



Art. no. 1199
Footbar for central lock,
at foot end

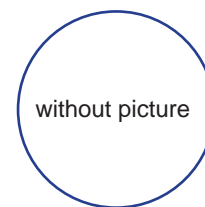

Art. no. 1190
5th castor, connectible,
in the centre of the under
frame

Side guards

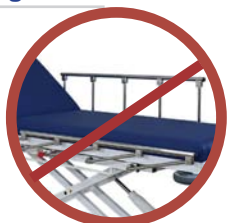

Art. no. 1080-EF
Without basic side rail (1 piece)



Art. no. 1040
1 side guard tiltable, chromium-plated,
completely made of steel tube,
length: 700 mm, with wall protection bum-
pers Ø 150 mm



Art. no. 1005
1 side guard to fit on side rail, with
attachment clamp, chromium-plated,
length: 800 mm,

Paper roll holder



Art. no. 1267K / 1268K
Paper roll holder, mounted
under head part, for width 650
mm / 800 mm

Upholstery options

Art. no. 2320-800
Width of upholstery 800 mm,
width overall 950 mm

Art. no. 1765 / 1780
Soft covering for pleasant resting
comfort, for width 650 mm / 800 mm,
thickness 80 mm

Add-on elements



Art. no. 1410
1 piece of side rail, length: 350 mm



Art. no. 1430
1 attachment clamp for side rail,
suitable for pipe: Ø 18 mm



Art. no. 1450
Infusion pole for side rail,
without attachment clamp



Art. no. 1850
Storage basket with mounting,
measures:
L. 530 x W. 370 x H. 80 mm

Series 2000XL: Recovery and patient transport tables

2-sectioned Recovery and patient transport table with hydraulic height and inclination adjustment

Length head part: 750 mm

Model 2310-00XL/H white powder coated (RAL 9010)

Model 2310-03XL/H white aluminium powder coated (RAL 9006)

Model 2310-04XL/H silver aluminium powder coated (RAL 9007)

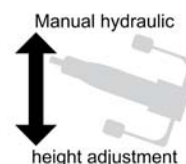

Both pictures:
Model 2310-00XL/H
with options: Width of upholstery 800 mm (2310-800), paper roll holder (1268K), side rail (1410), Storage basket (1850)

Basic equipment:

- Pedals for foot-controlled height positioning on both sides of the table
- Table movable on 4 comfort twin castors, Ø 125 mm, with central lock, 1 castor with direction lock
- 2 push handles at head and foot part, chromium-plated
- 2 side guards, foldable, chromium-plated, length: 1060 mm
- 4 wall protection bumpers, Ø 200 mm
- Recovery upholstery
- Dewert-hygiene-equipment 

Upholstery:

Lying surface 2-sectioned:

- Head part stepless adjustable from 0° to +75° by gas spring (sitting position)
- Length head part: 750 mm
- Fixed foot part
- Length foot part: 1200 mm
- Lying surface incinable till 12° (Trendelenburg) by gas spring
- Upholstery thickness: 80 mm



Picture shows additionally:
Attachment clamp for side rail (1430), infusion p
for side rail (1450) with accessoires

Technical data:

- Manual foot operated height adjustment: 640 mm to 1060 mm by hydraulic pump, pressure capacity of 10000 N
- Length of lying surface: 1950 mm | Length overall: 2200 mm
- Width of lying surface: 650 mm | Width overall: 800 mm | optional width: 800 mm, width overall: 950 mm
- Load capacity: 250 kg 

Design:

2 different variants for artificial leather eligible for upholstery covering:

- Skai® Pandoria Plus with velvet-smooth surface
- Skai® Toronto EN with innovative staynu-technology



Available as an option (see pricelist for additional options)

Mobility



Art. no. 1183
Without basic mobility



Art. no. 1195
Movable on comfort twin castors, Ø 150 mm with central lock, antistatic, basic height + 70 mm



Art. no. 1199
Footbar for central lock, at foot end

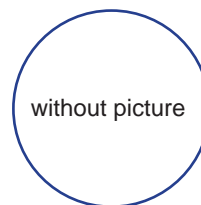

Art. no. 1190
5th castor, connectible, in the centre of the under frame

Side guards



Art. no. 1080-EF
Without basic side rail (1 piece)



Art. no. 1040
1 side guard tiltable, chromium-plated, completely made of steel tube, length: 700 mm, with wall protection bumpers Ø 150 mm



Art. no. 1005
1 side guard to fit on side rail, with attachment clamp, chromium-plated, length: 800 mm,

Paper roll holder



Art. no. 1267K / 1268K
Paper roll holder, mounted under head part, for width 650 mm / 800 mm

Upholstery options

Art. no. 2310-800
Width of upholstery 800 mm, width overall 950 mm

Art. no. 1765 / 1780
Soft covering for pleasant resting comfort, for width 650 mm / 800 mm, thickness 80 mm

Add-on elements



Art. no. 1410
1 piece of side rail, length: 350 mm



Art. no. 1430
1 attachment clamp for side rail, suitable for pipe: Ø 18 mm



Art. no. 1450
Infusion pole for side rail, without attachment clamp



Art. no. 1850
Storage basket with mounting, measures:
L. 530 x W. 370 x H. 80 mm

Series 2000XL: Recovery and patient transport tables

2-sectioned recovery and patient transport table with hydraulic height and inclination adjustment and detachable mattress

Length head part: 730 mm

Model 2410-00/XLH white powder coated (RAL 9010)

Model 2410-03/XLH white aluminium powder coated (RAL 9006)

Model 2410-04/XLH silver aluminium powder coated (RAL 9007)

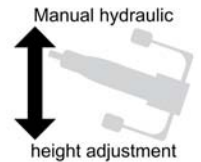

All pictures:
Model 2410-00XL/H
with option:
Storage basket (1850)

Basic equipment:

- Pedals for foot-controlled height positioning on both sides of the table
- Table movable on 4 comfort twin castors, Ø 150 mm, with central lock, antistatic, 1 castor with direction lock
- Foot bar, chromium-plated, at foot side, facilitates operation of central locking system
- Push handles at head and foot part, chromium-plated, at head part: 2 sectioned
- 2 side guards, foldable, chromium-plated, length: 1060 mm
- 4 wall protection bumpers, Ø 200 mm
- Detachable mattress
- Dewert-hygiene-equipment 



Upholstery:

Lying surface 2-sectioned:

- Head part stepless adjustable from 0° to +70° (sitting position) by gas spring
- Length head part: 730 mm
- Fixed foot part
- Length foot part: 1200 mm
- Lying surface inclinable till 12° (Trendelenburg) by gas spring
- Special feature: Detachable mattress, see on the right

Technical data:

- Manual foot operated height adjustment: 690 mm to 1110 mm by hydraulic pump, pressure capacity of 10000 N
- Length of lying surface: 1930 mm | Length overall: 2030 mm
- Width of lying surface: 650 mm | Width overall: 800 mm | optional width: 800 mm, width overall: 950 mm
- Load capacity: 250 kg 

Design:

2 different variants for artificial leather eligible for upholstery covering:

- Skai® Pandoria Plus with velvet-smooth surface
- Skai® Toronto EN with innovative staynu-technology

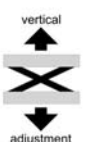

Available as an option (see pricelist for additional options)

Mobility

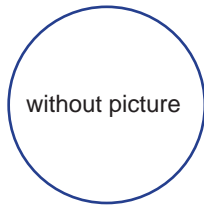

Art. no. 1190
5th castor, connectible, in the centre of the under frame

Paper roll holder

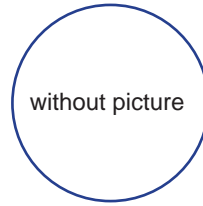

Art. no. 1267K / 1268K
Paper roll holder, mounted under head part, for width 650 mm / 800 mm

Storage basket



Art. no. 1850
Storage basket with mounting, measures:
L. 530 x W. 370 x H. 80 mm

Add-on elements



Art. no. 1410
1 piece of side rail, length: 350 mm



Art. no. 1430
1 attachment clamp for side rail, suitable for pipe: Ø 18 mm



Art. no. 1450
Infusion pole for side rail, without attachment clamp

Upholstery options

Art. no. 2410-800
Width of upholstery 800 mm, width overall 950 mm

Special feature: Mattress:

- Detachable mattress, thickness: 10 cm
- Upholstery made of high-quality resilience (cold) foam, covered with leatherette
- Mattress with velcro fastening and zipper at the bottom
- Support plate for mattress made of HPL panels (resistant to disinfectants)
- Head and foot part hanging together without joints



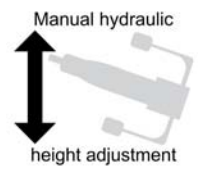

Series DX1 Recovery and patient transport tables with hydraulic height adjustment



Technology:



- Manual foot operated height adjustment by hydraulic pump
- Pedals for foot-controlled height positioning **on both sides** of the table
- Load capacity: 225 kg 
- Very stable **single frame scissor lifting system**, with high torsional stiffness due to thick-walled square tubes with big dimensions, also for under and upper frame and scissor
- High stability due to massive 20 mm axes
- Widely-spaced feet and a high deadweight guarantee stability
- Robust frame construction which is proven in demanding everyday life of hospitals for years
- Abrasion-resistant guide system at under and upper frame due to the use of roller bearings

Basic equipment:



- **Recovery upholstery:** Increased lying comfort due to medium-soft upholstery with a cold foam cover
- **Movable** on 4 twin castors, Ø 100 mm, with central lock
- 2 foldable **side guards**, lay down besides upholstery, below upholstery surface level, are completely made of steel tube without any breakable plastic components RAL 9006 powder coated, length: 820 mm
- Good handling when pushing the table due to four **push handles** placed at the frame outside points, RAL 9006 powder coated
- Longitudinal and lateral wall protection due to four **wall bumpers**
- **Dewert-hygiene-equipment**



You will find additional options on the following pages

Series DX1: Recovery and patient transport tables with hydraulic height adjustment

Variants:

Length head part 550 mm:

- Head part stepless adjustable by gas spring (0° to +65°)



Length head part 750 mm:

- Comfortable stepless adjustment of head part by gas spring (0° to +75°) to sitting position of patient



With 2-sectioned lying surface:

- Fixed foot part, not adjustable

With 3-sectioned lying surface:

- Foot part positive to +35° adjustable by gas spring
- Fixed middle part
- Adjustable foot part with tubular steel frame for high torsion rigidity
- Pressure stable gas spring ensures working at the foot part without vibrations
- Operating lever to manipulate the gas spring easily accessible, positioned at the foot end

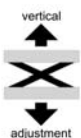



Series DX1

2-sectioned recovery and patient transport table with hydraulic height adjustment

- Model 1090-00/H white powder coated (RAL 9010)
- Model 1090-03/H white aluminium powder coated (RAL 9006)
- Model 1090-04/H silver aluminium powder coated (RAL 9007)

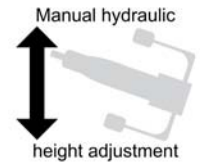

Both pictures:
Model 1090-04/H
with option:
Storage basket (B1850)

Basic equipment:

- Pedals for foot-controlled height positioning on both sides of the table
- Movable on twin castors, Ø 100 mm, with central lock, 1 castor with direction lock
- Push handles at head part and foot part, RAL 9006 powder coated
- 2 side guards, foldable, RAL 9006 powder coated, length: 820 mm
- 4 wall protection bumpers, Ø 200 mm
- Upholstery medium-soft (high-quality cold foam cover)
- Dewert-hygiene-equipment



Upholstery:

Lying surface 2-sectioned:

- Head part stepless adjustable by gas spring (0° to 65°)
- Length head part: 550 mm
- Fixed foot part
- Length foot part: 1400 mm
- Upholstery thickness: 60 mm



Technical data:

- Manual foot operated height adjustment: 500 mm to 950 mm by hydraulic pump, pressure capacity of 10000 N
- Width of lying surface: 700 mm, width overall: 780 mm
- Length of lying surface: 1950 mm, length overall: 2060 mm
- Load capacity: 225 kg, according to IEC 60601 tested with fourfold static load
- Load capacity head part: 90 kg



Design:

2 different variants for artificial leather eligible for upholstery covering:

- Skai® Pandoria Plus with velvet-smooth surface
- Skai® Toronto EN with innovative staynu-technology

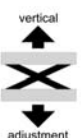

Available as an option (see pricelist for additional options)

Mobility



Art. no. 1181
Without basic mobility



Art. no. B1185
Movable on comfort twin
castors, Ø 125 mm with central lock,
basic height + 30 mm



Art. no. B1199
Footbar for central lock,
at foot end

Paper roll holder



Art. no. 011K / 013K
Paper roll holder, mounted under head
part, for width 700 mm / 800 mm

Upholstery options

Art. no. 016
Width 800 mm

Art. no. B1770 / B1780
Soft covering for pleasant resting
comfort, for width 700 mm/ 800 mm,
thickness 80 mm

Add-on elements



Art. no. B1410
1 piece of side rail, length: 350 mm



Art. no. B1430
1 attachment clamp for side rail,
suitable for pipe Ø 18 mm



Art. no. B1450
Infusion pole, without attachment clamp



art. no B1850
Storage basket,
measures:
L. 530 x W. 370 x H. 80 mm

NEW

Series DX1 2-sectioned recovery and patient transport table with hydraulic height adjustment

- Model 1093-00/H white powder coated (RAL 9010)
- Model 1093-03/H white aluminium powder coated (RAL 9006)
- Model 1093-04/H silver aluminium powder coated (RAL 9007)

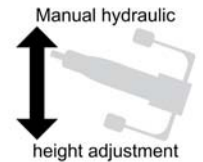

Both pictures:
Model 1093-04/H
with basic equipment

Basic equipment:

- Pedals for foot-controlled height positioning on both sides of the table
- Movable on twin castors, Ø 100 mm, with central lock, 1 castor with direction lock
- Push handles at head part and foot part, RAL 9006 powder coated
- 2 side guards, foldable, RAL 9006 powder coated, length: 820 mm
- 4 wall protection bumpers, Ø 200 mm
- Upholstery medium-soft (high-quality cold foam cover)
- Dewert-hygiene-equipment



Upholstery:

Lying surface 2-sectioned:

- Head part stepless adjustable by gas spring (0° to +75°) (sitting position)
- Length head part: 750 mm
- Fixed foot part
- Length foot part: 1200 mm
- Upholstery thickness: 70 mm



Technical data:

- Manual foot operated height adjustment: 540 to 990 mm by hydraulic pump, pressure capacity of 10000 N
- Width of lying surface: 700 mm, width overall: 780 mm
- Length of lying surface: 1950 mm, length overall: 2060 mm
- Load capacity: 225 kg, according to IEC 60601 tested with fourfold static load
- Load capacity head part: 90 kg



Design:

2 different variants for artificial leather eligible for upholstery covering:

- Skai® Pandoria Plus with velvet-smooth surface
- Skai® Toronto EN with innovative staynu-technology

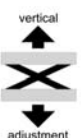

Available as an option (see pricelist for additional options)

Mobility



Art. no. 1181
Without basic mobility



Art. no. B1185
Movable on comfort twin
castors, Ø 125 mm with central lock,
basic height + 30 mm



Art. no. B1199
Footbar for central lock,
at foot end

Paper roll holder



Art. no. 011K / 013K
Paper roll holder, mounted under head
part, for width 700 mm / 800 mm

Upholstery options

Art. no. 016
Width 800 mm

Art. no. B1770 / B1780
Soft covering for pleasant resting
comfort, for width 700 mm/ 800 mm,
thickness 80 mm

Add-on elements



Art. no. B1410
1 piece of side rail, length: 350 mm



Art. no. B1430
1 attachment clamp for side rail,
suitable for pipe Ø 18 mm



Art. no. B1450
Infusion pole, without attachment clamp



art. no B1850
Storage basket,
measures:
L. 530 x W. 370 x H. 80 mm



Series DX1

3-sectioned recovery and patient transport table with hydraulic height adjustment

- Model 1095-00/H white powder coated (RAL 9010)
- Model 1095-03/H white aluminium powder coated (RAL 9006)
- Model 1095-04/H silver aluminium powder coated (RAL 9007)

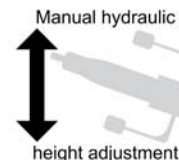

Both pictures:
Model 1095-00/H
with options:
Movable on comfort twin
castors with central lock
(B1185), side rail (B1410)

Basic equipment:

- Pedals for foot-controlled height positioning on both sides of the table
- Movable on twin castors, Ø 100 mm, with central lock, 1 castor with direction lock
- Push handles at head part and foot part, RAL 9006 powder coated
- 2 side guards, foldable, RAL 9006 powder coated, length: 820 mm
- 4 wall protection bumpers, Ø 200 mm
- Upholstery medium-soft (high-quality cold foam cover)
- Dewert-hygiene-equipment



Upholstery:

Lying surface 3-sectioned:

- Head part stepless adjustable by gas spring (0° to +65°)
- Length head part: 550 mm
- Fixed middle part
- Length middle part: 480 mm
- Foot part stepless adjustable by gas spring (0° to +50°)
- Length foot part: 920 mm
- Upholstery thickness: 70 mm



Model 1095-00/H with options:
Movable on comfort twin castors with central lock
(B1185), side rail (B1410)

Technical data:

- Manual foot operated height adjustment: 520 mm to 970 mm by hydraulic pump, pressure capacity of 10000 N
- Width of lying surface: 700 mm, width overall: 780 mm
- Length of lying surface: 1950 mm, length overall: 2060 mm
- Load capacity: 225 kg, according to IEC 60601 tested with fourfold static load
- Load capacity head part: 90 kg



Design:

2 different variants for artificial leather eligible for upholstery covering:

- Skai® Pandoria Plus with velvet-smooth surface
- Skai® Toronto EN with innovative staynu-technology



Available as an option (see pricelist for additional options)

Mobility



Art. no. 1181
Without basic mobility



Art. no. B1185
Movable on comfort twin castors, Ø 125 mm with central lock, basic height + 30 mm



Art. no. B1199
Footbar for central lock, at foot end

Paper roll holder



Art. no. 011K / 013K
Paper roll holder, mounted under head part, for width 700 mm / 800 mm

Upholstery options

Art. no. 017
Width 800 mm

Art. no. B1770 / B1780
Soft covering for pleasant resting comfort, for width 700 mm/ 800 mm, thickness 80 mm

Add-on elements



Art. no. B1410
1 piece of side rail, length: 350 mm



Art. no. B1430
1 attachment clamp for side rail, suitable for pipe Ø 18 mm



Art. no. B1450
Infusion pole, without attachment clamp

+ Additional equipment

Cushions



Art. no. 1211-..*
Wedge shaped bolster, measures (L. x W. x H.): 400 x 400 x 100 - 10 mm

*Add colour number



Art. no. 1113-..*
Half roll bolster, measures (L. x W. x H.): 570 x 200 x 95 mm



Art. no. 1111-..*
Neck roll, measures: L. 570 x Ø 150 mm



Art. no. 1112-..*
Knee roll, measures: L. 570 x Ø 200 mm



Art. no. 1314-..*
Cushion, velcro fixation, ticking with polyester filling, measures (L. x W.): 400 x 400 mm

Upholstery protection mat



Art. no. 1890
Protection mat, made of PVC, thickness: 0.8 mm, measures: 700 x 600 mm

You will find the whole Dewert product range with additional articles and equipment on our website and in our further catalogues. We look forward to hear from you!



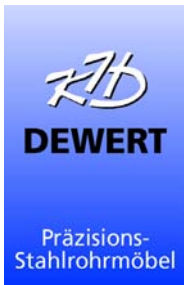

K.H. Dewert GmbH
Vollmestraße 7
33649 Bielefeld
Germany

Post office 14 40 28
33634 Bielefeld
Germany

Phone + 49 (0) 5 21 / 4 00 27-0
Fax + 49 (0) 5 21 / 4 00 27-27

Internet: www.khdewert.de
E-Mail: info@khdewert.de
YouTube: K.H. Dewert



... WITH FIXED
HEIGHT



RECOVERY AND PATIENT TRANSPORT TABLES



... WITH HYDRAULIC HEIGHT ADJUSTMENT

